

POWER AND MOTION CONTROL



SERVI CYLINDERSERVICE AS



POWER AND MOTION CONTROL

SAFETY

FOR YOUR OWN SAFETY, PLEASE NOTICE



FIRE: Leave the building immediately, be near your host and follow them to the arena outside the main entrance.

FIRST-AID: If you feel unwell or need help - contact your host or reception.

SAFETY: In the workshop it is mandatory to wear safety equipment like footwear and vest. Other protective equipment must be used when necessary. Exceptions can only be made by the managing director or manager of the workshop. (Eg tour groups)

SMOKING: It is not allowed to smoke within the company area.

FOTO: Only allowed on request.

HISTORY

SERVI CYLINDERSERVICE AS



1936 Cylinderservice AS established by Sverre A Harang. Overhaul of internal combustion engines.

1952 Manufacture of compressors.

1957 Production of cylinders for hydraulic and pneumatic systems.

1962 production of hydraulic cylinders and systems.

1967 Cylinderservice AS establishes itself in Rissa.

1974 Cylinderservice AS expands, has production facilities in 10.000m² Rissa and in Trondheim.

1984 Work on a quality-system starts.

1991 Part of the activities in Trondheim will be sold to the Danish company Sophus Berendsen A / S.

1993 ISO-9001 approval.

2002 Corporate Department in Rissa is currently acquires by Servi AS. Name Servi Cylinderservice AS.

2009 Servi Cylinderservice AS changes its name to PMC Servi Cylinderservice AS.

2012 PMC Servi Cylinderservice AS changes its name to PMC Cylinderservice AS.

2013 PMC Group Norway AS is acquired by FERD and change the name from PMC Cylinderservice AS to **Servi Cylinderservice AS.**

LOCATIONS



NORWAY:

Servi Hydranor AS (Ski, Kongsberg, Tønsberg, Kristiansand, Sandnes, Bergen, Trondheim)

Servi Cylinderservice AS (Rissa)

Servi Ulsteinvik AS

USA:

Servi Hydranor Inc. (Houston)

24/7 Service phone number:
64 97 97 00



ORGANISATION

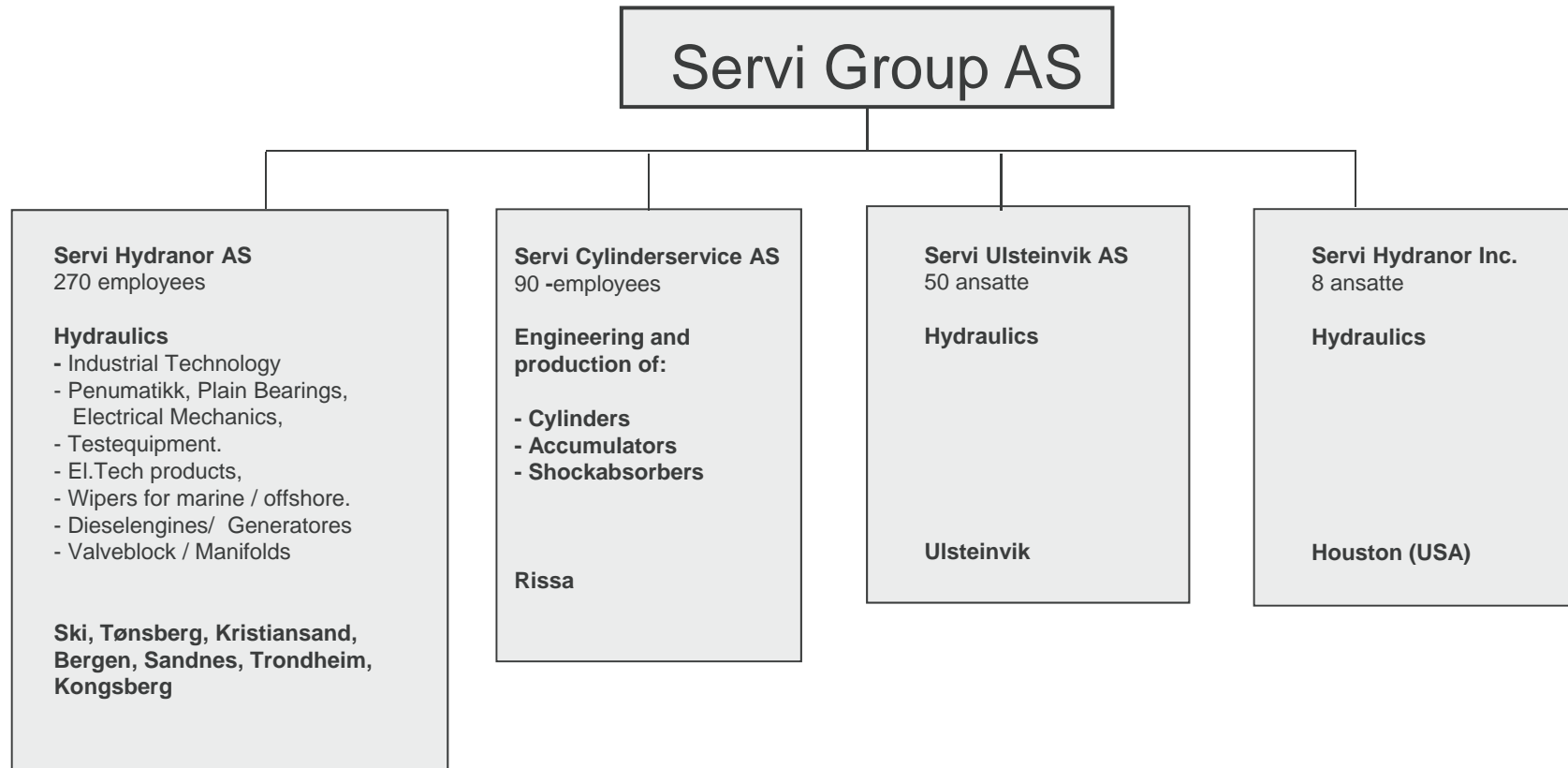

ORGANISATION

SERVI CYLINDERSERVICE AS

SERVI
GROUP™

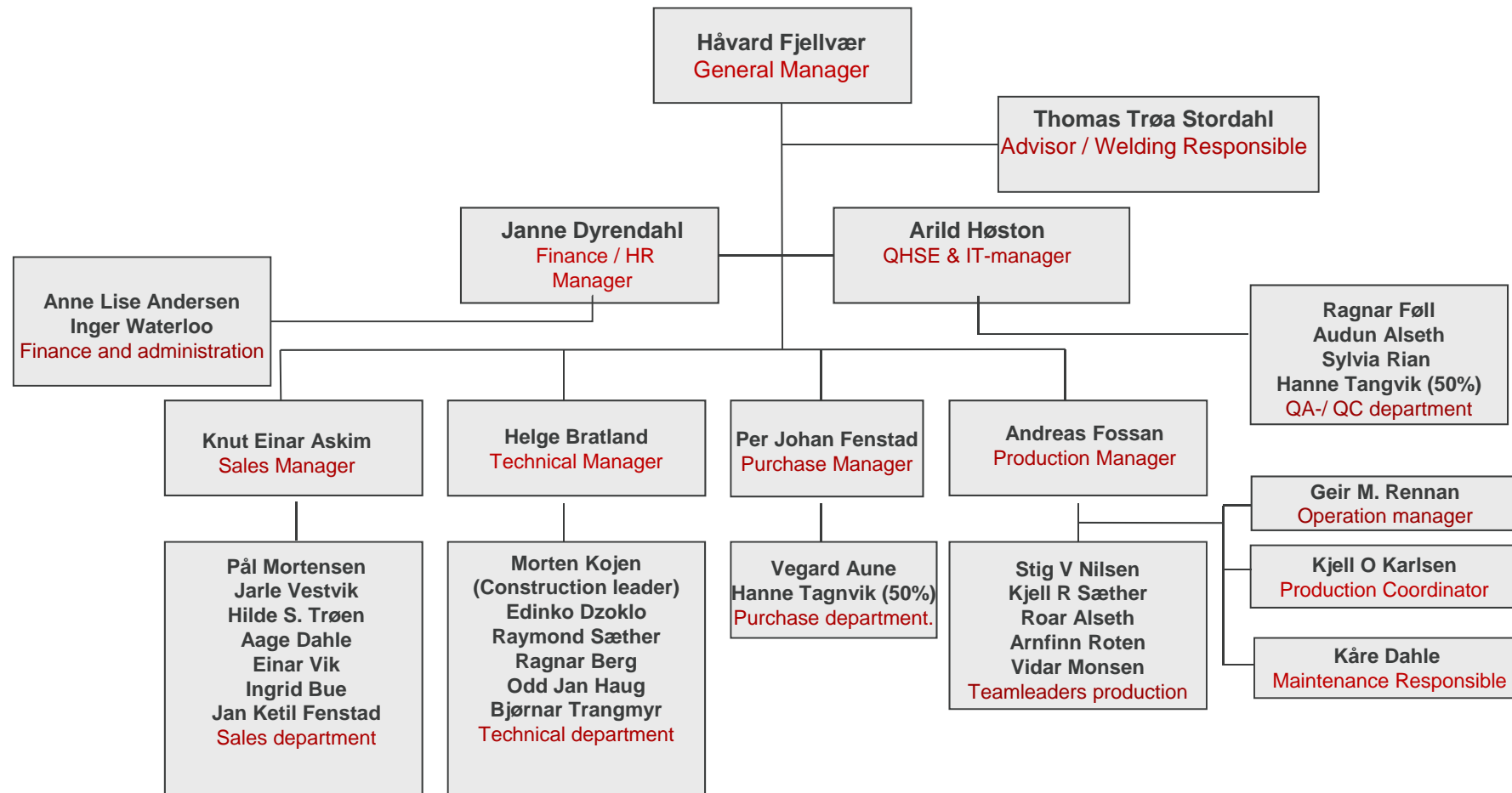

INTERN ORGANISERING

SERVI CYLINDERSERVICE AS



Total approx. 90 employees, including

64 employees in production:

33 machinists / industrial mechanics.

3 Apprentices.

6 installers.

5 welders.

6 storage and transport.

11 Production management including team leaders and planners.

26 employees in administration:

6 Sales Department.

5 Finance / Administration / management

6 Technical Department.

3 QA-/ QC department

3 Purchasing Department.

3 Planning department

GENERAL

SERVI CYLINDERSERVICE AS

SERVI
GROUP™

is the largest manufacturer of hydraulic cylinders in Norway.
We have advanced machines and a fully integrated MPS system.
We also have expertise in construction, hydraulics, machining, welding, material technology.
This makes us a versatile partner.

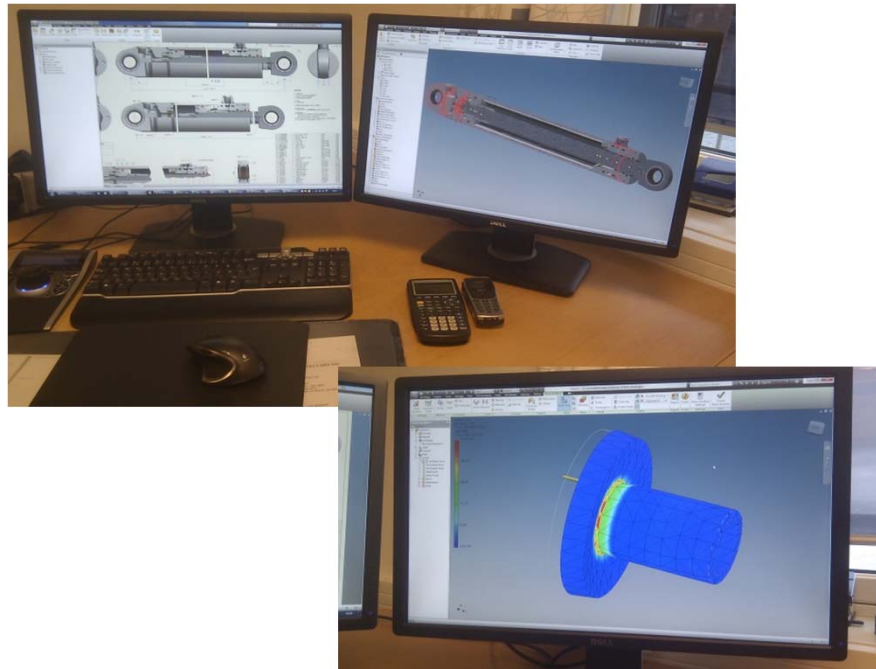

COMMERCIAL IDEA.

Servi Cylinderservice AS will develop and manufacture hydraulic cylinders and other hydraulic products for the European market.

Servi Cylinderservice AS will also market and sell services in repair and maintenance of all types of cylinders, and carry out assignments in mechanical maintenance, machining and welding.

POWER AND MOTION CONTROL

QUALITY POLICY

SERVI CYLINDERSERVICE AS



Servi Cylinderservice AS shall satisfy customer requirements and expectations.

We will do this by:

- Delivering the right quality at the right time.
- Adding product value for customers.
- Measuring results and follow up discrepancies
- Develop products and processes and continual improvement.

Servi Cylinderservice AS quality system is built for and certified by the guidelines given in ISO 9001:2008.

HSE POLICY

SERVI CYLINDERSERVICE AS



Servi Cylinderservice AS has a high focus on a safe working environment. We strive for a zero philosophy: All accidents can be avoided and no accidents are acceptable.

We will achieve this by:

- Report any deviations and potential deviations.
- We should stop all unsafe activities.
- Emphasize HSE work in line with the business process.

ONGOING INVESTMENTS



- New workshop 1195m² – Hall 6,
- 5 nye machines – 4 pcs in Hall 6 + 1 pcs in Hall I
 - 1 Honing machine - Sunnen HTS 124-130 (Hall 6)
 - 1 Milling machine – FPT Versus (Hall 6)
 - 1 turning machine - Takang FA80x14150 (Hall 6)
 - 1 turning machine – Takang FA55x8150 (Hall 6)
 - 1 multi machine – Mazak Integrex e500HS-II (Hall I)
- Implementation phase May 2014 – May 2015

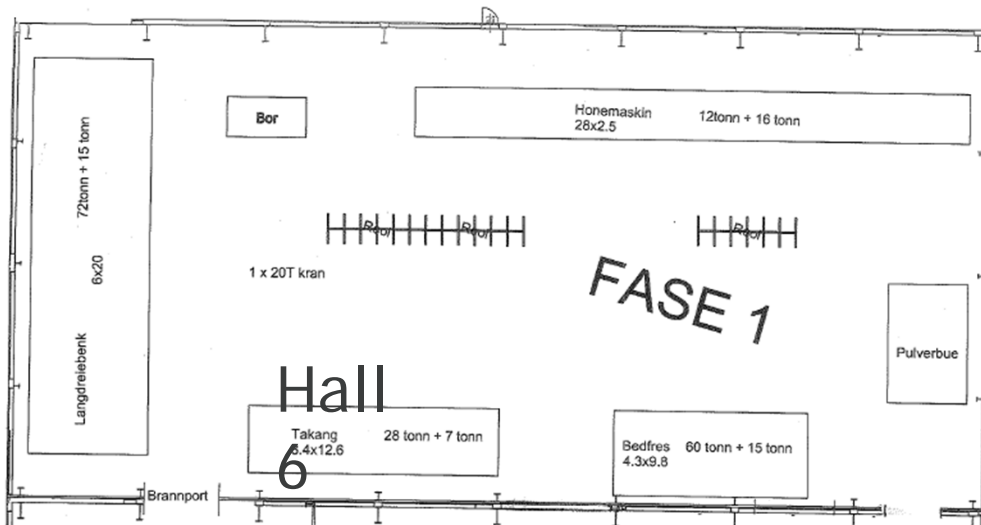

ONGOING INVESTMENTS

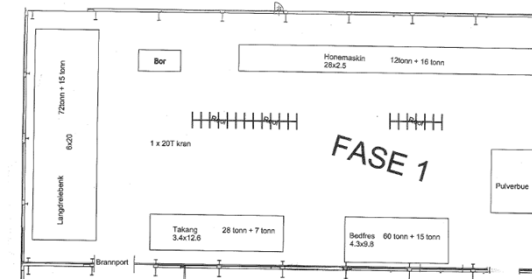

MULTI MACHINE:
Mazak Integrex E500HSx1500



HONING MACHINE: Sunnen HTS I24-130



POWER AND MOTION CONTROL

ONGOING INVESTMENTS

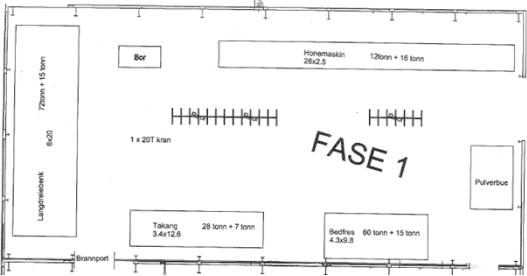

Milling machine: FPT Verus M80



Turning Machine: Takang FA80x14150
Turning Machine: Takang FA55x8150
(Picture of FA60)



POWER AND MOTION CONTROL

ONGOING INVESTMENTS

- New workshop: 1200 m2 - Hall 7
- New locations for Norsk Coating AS (surface coating)
- Packing and shipping.

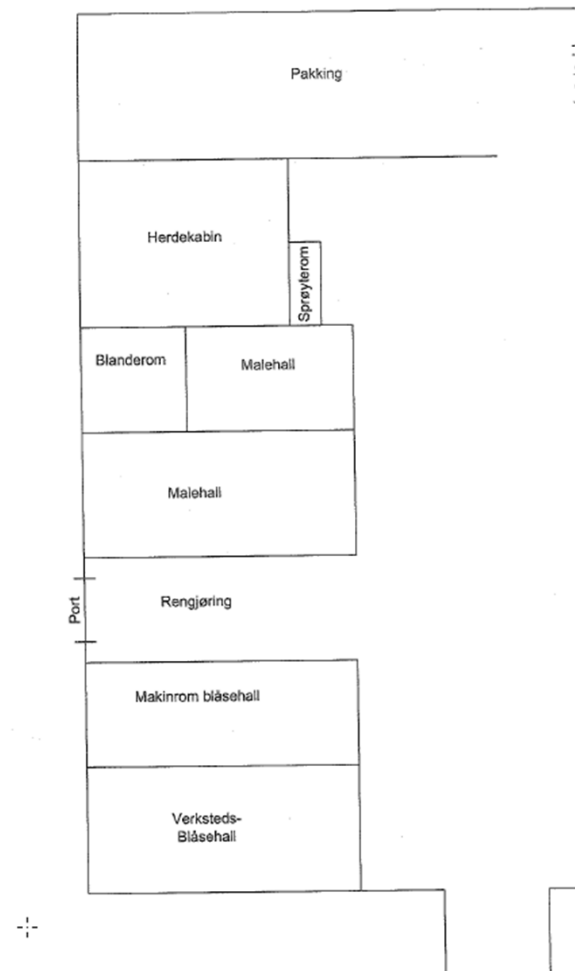

DnV CERTIFICATES

SERVI CYLINDERSERVICE AS



- NS-EN ISO 9001:2008, since 1993.
- TYPE APPROVAL CERTIFICATE: HYDRAULIC CYLINDERS – Up to Ø700 mm
- MANAGEMENT SYSTEM CERTIFICATE
- MANUFACTURING SURVEY ARRANGEMENT: MSA
- EC TYPE-EXAMINATION CERTIFICATE: PED-B-61. REV. I.
- EC TYPE-EXAMINATION CERTIFICATE: DNV-2007-OSL-ATEX-3520X.
- QS CERTIFICATE OF ASSESSMENT EC: PED-D-43.

PRODUCTS AND SERVICES

SERVI CYLINDERSERVICE AS

SERVI
GROUP™

Machining.

Milling-

We can perform milling on pieces 1000 x 1700 x 4400 mm in one mounting.



POWER AND MOTION CONTROL

PRODUCTS AND SERVICES

SERVI CYLINDERSERVICE AS

SERVI
GROUP™

Machining.

Turning -

We have a wide range of lathes that can handle a wide range of machining tasks.

CNC lathes with up to work $\text{Ø} 1075 \times 6000$ mm.

Manual lathes with work up to $\text{Ø}360 \times 15000$,
 $\text{Ø}1200 \times 8000$ mm.



POWER AND MOTION CONTROL

PRODUCTS AND SERVICES

SERVI CYLINDERSERVICE AS

SERVI
GROUP™

Machining.

Honing -

From 10 to 800mm in diameter and up to
10000 mm in length.

400 x 10000 mm

800 x 6000 mm

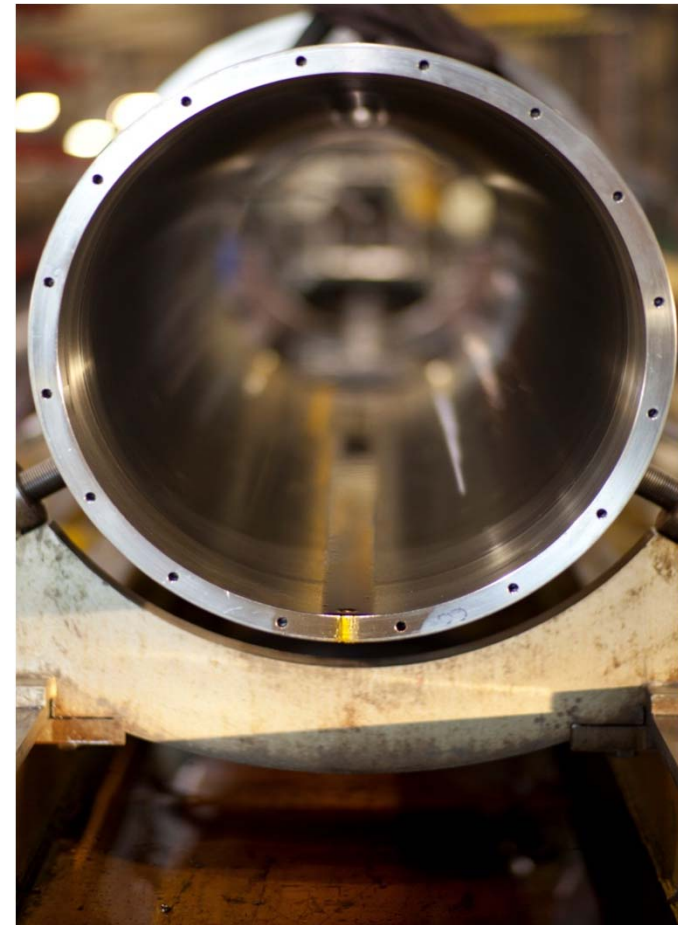

POWER AND MOTION CONTROL

PRODUCTS AND SERVICES

SERVI CYLINDERSERVICE AS

SERVI
GROUP™

Machining.

Sawing / cutting -

From 1 to 620mm in diameter

Limitations:

90 degree cut.

Max. 10 tons (limited due. crane capacity).



POWER AND MOTION CONTROL

PRODUCTS AND SERVICES

SERVI CYLINDERSERVICE AS

SERVI
GROUP™

Welding.

Welding -

Certified welders and qualified welding-procedures for carbon steels, stainless steels, duplex, superduplex.



POWER AND MOTION CONTROL

PRODUCTS AND SERVICES

SERVI CYLINDERSERVICE AS

SERVI
GROUP™

Repairing/ Overhauling/ Service/ After sale.



Servi Cylinderservice AS has its own **repair department** which undertakes repairs / service on all makes of hydraulic cylinders, piston accumulators and hydraulic dampers.

Spareparts / after sale:

We sell our semifinished products, sensors, seals, bearings ++.

POWER AND MOTION CONTROL

PRODUCTS AND SERVICES

SERVI CYLINDERSERVICE AS

SERVI
GROUP™

Engineering / Design

At Servi Cylinderservice AS we develop, design and calculate hydraulic cylinders, and cylinder based constructions such as piston accumulators, pressure tanks and shock absorbers. During development and design we are using Autodesk Inventor for modeling and drawing, and use Excel spread sheet and Autodesk Inventor Professional for strength calculations. .

During development, design, strength calculations and production, we are using this Soft Ware:

- Autodesk AutoCAD Mechanical, for drawings.
- Autodesk Inventor Professional, for modeling and drawings.
- Autodesk Vault Professional for file and revision control.
- Autodesk Inventor Professional, for Finite Element Analysis.
- Microsoft Excel, for various calculations and strength calculation and reports.
- Access to Simulation X, for hydraulic simulations and calculations.
- Edgcam, for Computed Aided Manufacturing (CAM).



MARKETS

SERVI CYLINDERSERVICE AS

SERVI
GROUP™

Offshore

In close cooperation with various system suppliers, we have supplied equipment to:

- Cylinders for winch and cranes
- Cylinders for pipehandling systems
- Cylinders for tension systems
- Accumulators and dampers for damping/landing systems and other equipments



MARKETS

SERVI CYLINDERSERVICE AS

SERVI
GROUP™

Subsea

Products demanding high quality.

Accumulators, compensators, cylinders and dampers also including products made of titanium and other high strength steels as duplex and superduplex.

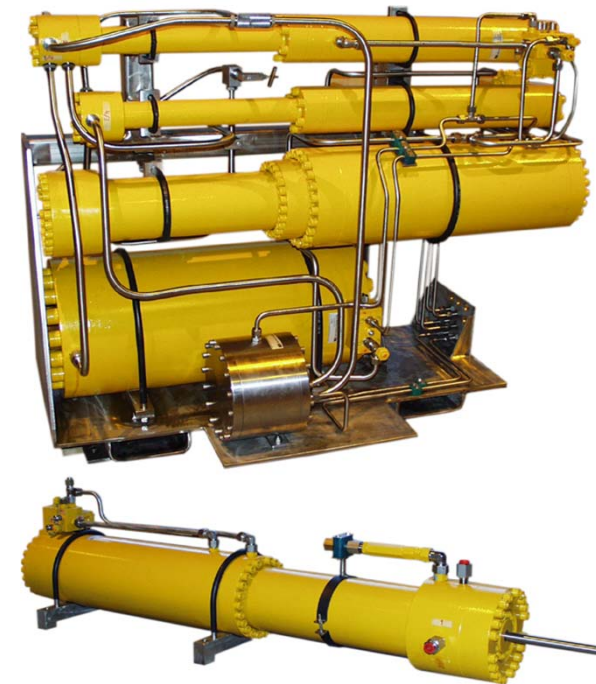

MARKETS

SERVI CYLINDERSERVICE AS

SERVI
GROUP™

Maritime applications

We supply cylinders / dampers / accumulators for many different applications on board:

- Cranes
- Winch
- Deck Equipment
- Thrusters
- Pallet load systems.
- Heave compensation systems
- Mooring systems



POWER AND MOTION CONTROL

MARKETS

SERVI CYLINDERSERVICE AS

SERVI
GROUP™

Industri

Cylinders to applications as:

- Winch, ports, hatch and cranes

Mostly water power and smelting plants.



TENSION CYLINDERS

SERVI CYLINDERSERVICE AS

SERVI
GROUP™

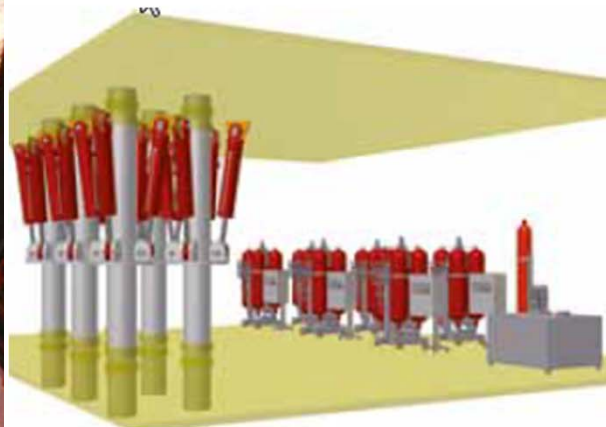

POWER AND MOTION CONTROL

OFFSHORE DRILLING (1/2)

SERVI CYLINDERSERVICE AS

SERVI
GROUP™

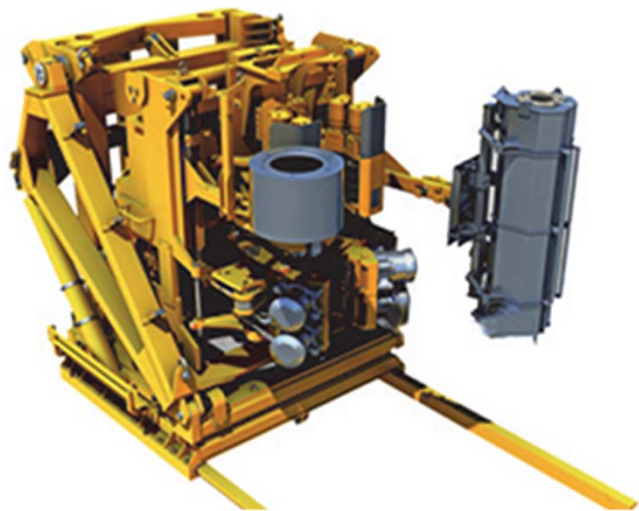

POWER AND MOTION CONTROL

OFFSHORE DRILLING (2/2)

SERVI CYLINDERSERVICE AS

SERVI
GROUP™



POWER AND MOTION CONTROL

CRANE CYLINDERS

SERVI CYLINDERSERVICE AS

SERVI
GROUP™



400T Offshore AHC Crane

DPAC

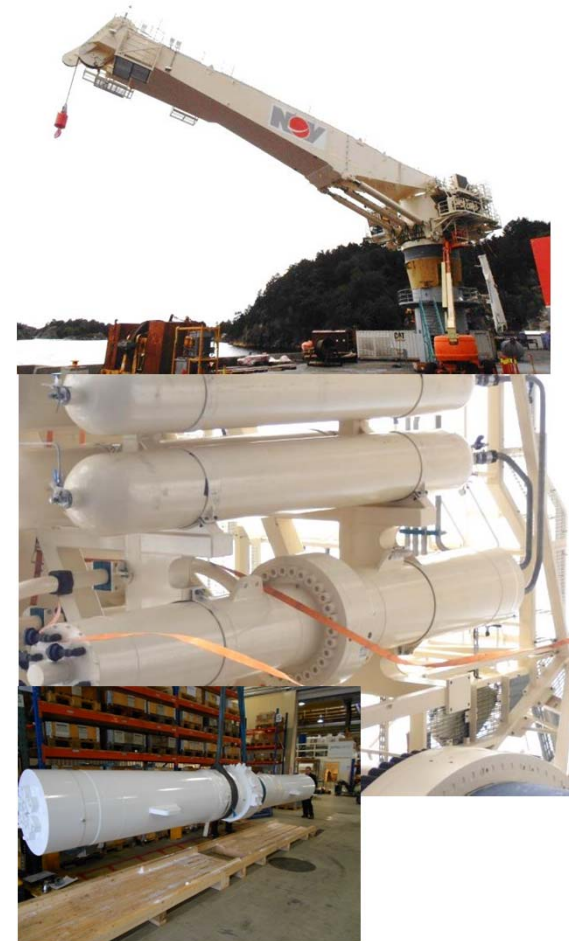

POWER AND MOTION CONTROL

SHOCK ABSORBERS

SERVI CYLINDERSERVICE AS

SERVI
GROUP™



400T Cranemaster

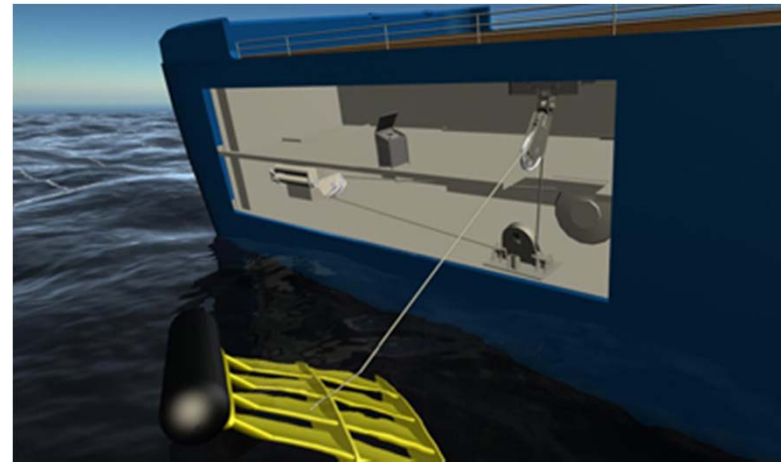

Seismic Shock absorber

POWER AND MOTION CONTROL

ACCUMULATORS

SERVI CYLINDERSERVICE AS

SERVI
GROUP™

Up to 1000 bar



POWER AND MOTION CONTROL

SUBSEA

SERVI CYLINDERSERVICE AS

SERVI
GROUP™

- Deliveries with different types of material qualities: Aisi 316 / Super Duplex / Duplex / Titan

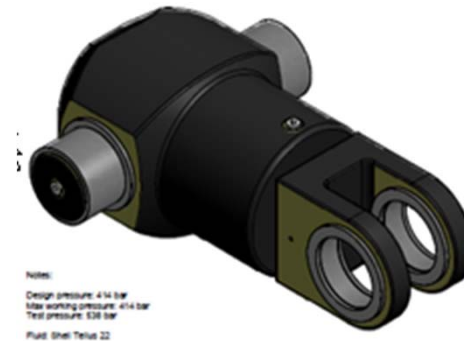
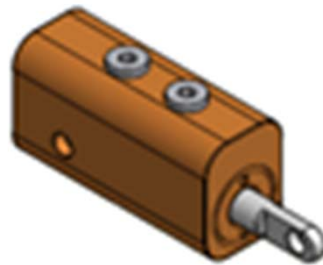
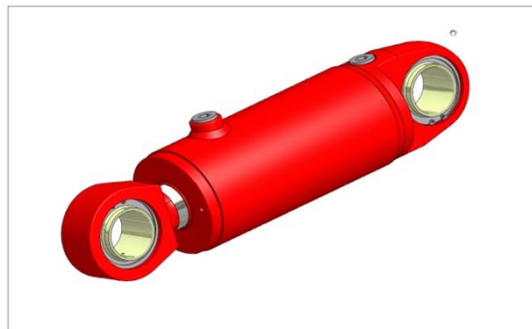

STANDARD CYLINDER

SERVI CYLINDERSERVICE AS

SERVI
GROUP™

DNV Type approved 250 bar cylinders

■ CD25 dim. Ø32-Ø400

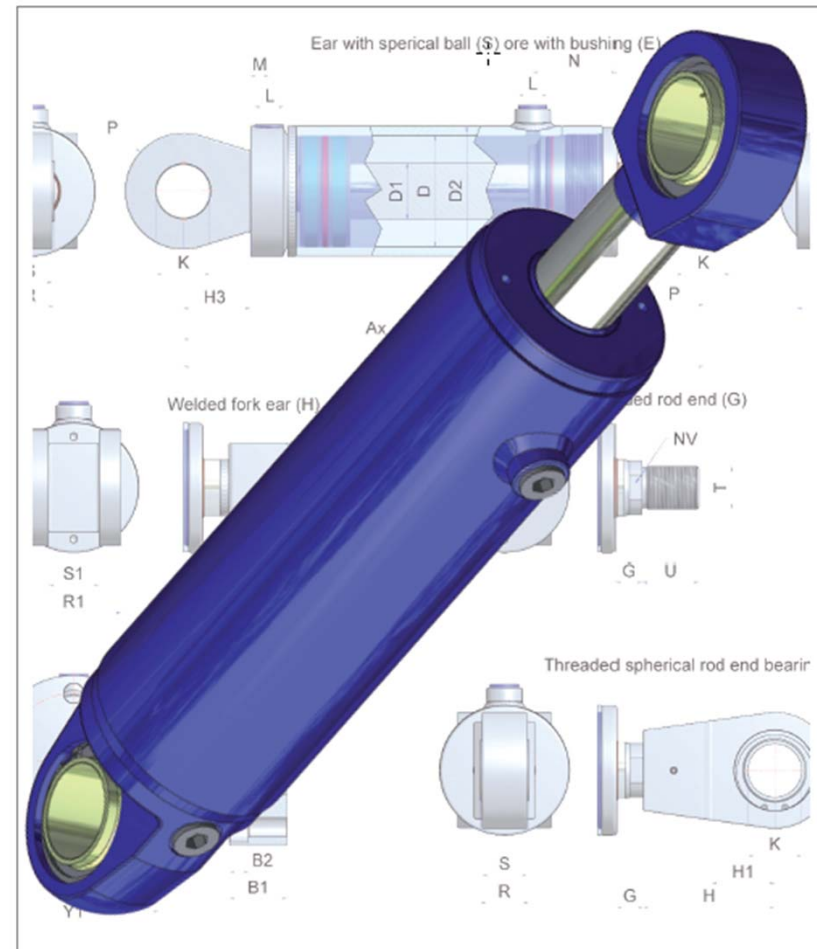

POWER AND MOTION CONTROL

***SERVI CYLINDERSERVICE AS
is large enough to provide good
service, and small enough to have
customer focus!***

www.servi.no

www.servikatalogen.no

POWER AND MOTION CONTROL

